

Consolidation Point Boxes

PANDUIT[®]

SPECIFICATION SHEET

specifications

Consolidation point boxes shall be used with low profile under floor systems and vertical and horizontal wall mount applications. The boxes shall accept up to 12, 24, or 48 modules. The box shall have top and bottom cable access with removable panels that include grommets to keep out debris.



technical information

Part Number	Height in (mm)	Width in (mm)	Depth in (mm)
CUFMB24BL	1.7 (43)	10.9 (276)	10.7 (271)
CUFB48BL	1.6 (41)	10.0 (254)	14.9 (378)
CUFMB12D4PBL	1.6 (41)	10.7 (271)	10.2 (258)

Mounting option: Vertical or horizontal wall mounting or low profile raised floor system (minimum depth of 1.7")

Packaging:

CUFMB24BL:	Box includes 24-port label and four Tak-Ty [®] Cable Ties
CUFB48BL:	Box includes 48-port label and six Tak-Ty [®] Cable Ties
CUFMB12D4PBL:	Box includes port identification labels and four Tak-Ty [®] Cable Ties
CUFF-KIT:	Fiber Conversion Kit includes four Pan-Ty [®] Cable Ties, two adhesive fiber spools, two support brackets with screws to hold fiber cable, one grounding lug, one laser warning label, one fiber warning label and 24" spiral wrap

key features and benefits

Modularity	Accepts all Mini-Com [®] Modules; individual modules snap in and out
Optional fiber conversion kits	Supports use in fiber applications
Removable panels	Allow Panduit T70 Raceway to be flush against panel for clean, wall mounted appearance
Center metal supports	Supports raised floor panels
UL 2043 approved	Suitable for use in air handling spaces

applications

The consolidation point box is designed to work with SMED NEXUS[™] Under Floor Systems as a consolidation point, although it is also suitable for other under floor systems with a minimum depth of 1.7". The box can also be wall mounted vertically or horizontally as a consolidation point. Consolidation point boxes

save time and money by reducing the amount of time required to complete moves, adds and changes.

Troubleshooting is also simplified as the connections can be tested and certified before installation.

NEXUS[™] is a registered trademark of SMED International Corporation, Calgary, Alberta, Canada.

Consolidation Point Box

24-port consolidation point box: CUFMB24BL

48-port consolidation point box: CUFB48BL

12-data port and 4-power port consolidation point box: CUFMB12D4PBL

Fiber conversion kit: CUFF-KIT

PanZone[®] Solid UTP Patch Cords**

Cat 6A SD, plenum, plug-plug, blue: UXPPBU*

Cat 6, plenum, plug-plug, blue: UPPBU*

PanZone[®] Solid STP Patch Cords**

Cat 6A, plenum, plug-plug, blue: SAPPBU*

Mini-Com[™] Modules

See website (www.panduit.com) or catalog for complete listing of modules for copper, fiber, and audio video installations.

* Zone cords are available in 10 to 100 ft lengths in 5 ft increments. And 100 to 150 ft lengths in 10 ft increments.

** Plug to Plug versions are listed. Jack to Plug and Jack to Jack options are also available.

Consolidation Point Boxes

CUFMB24BL

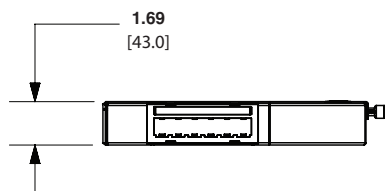
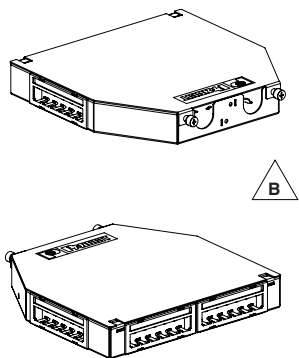
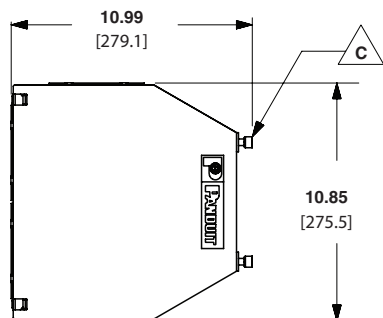

CUFB48BL

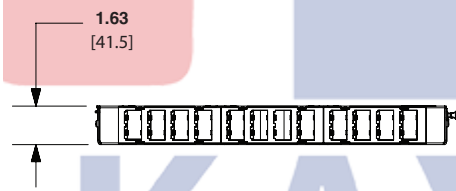
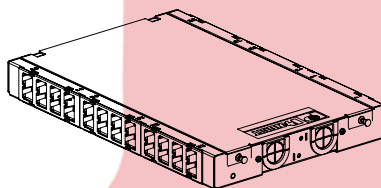
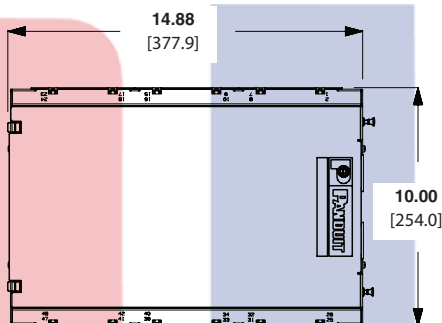

CUFMB12D4PBL

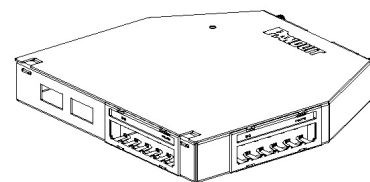
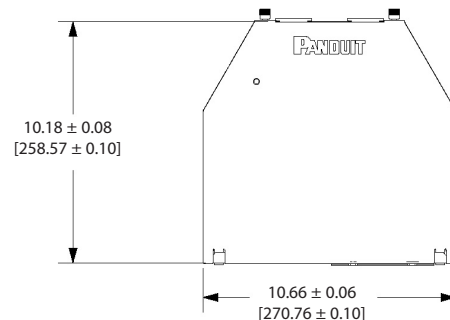

EL-KAYAN
TECHNOLOGY

Dimensions are in inches. [Dimensions in brackets are metric].

WORLDWIDE SUBSIDIARIES AND SALES OFFICES

PANDUIT CANADA
Markham, Ontario
cs-cdn@panduit.com
Phone: 800.777.3300

PANDUIT EUROPE LTD.
London, UK
cs-emea@panduit.com
Phone: 44.20.8601.7200

PANDUIT SINGAPORE PTE. LTD.
Republic of Singapore
cs-ap@panduit.com
Phone: 65.6305.7575

PANDUIT JAPAN
Tokyo, Japan
cs-japan@panduit.com
Phone: 81.3.6863.6000

PANDUIT LATIN AMERICA
Guadalajara, Mexico
cs-la@panduit.com
Phone: 52.33.3777.6000

PANDUIT AUSTRALIA PTY. LTD.
Victoria, Australia
cs-aus@panduit.com
Phone: 61.3.9794.9020

For a copy of Panduit product warranties, log on to www.panduit.com/warranty

For more information

Visit us at www.panduit.com

Contact Customer Service by email: cs@panduit.com
or by phone: 800.777.3300

PANDUIT[®]

©2017 Panduit Corp.
ALL RIGHTS RESERVED.
Printed in the U.S.A.
RKSP158--WW-ENG
Replaces WW--RKSP55
12/2017